

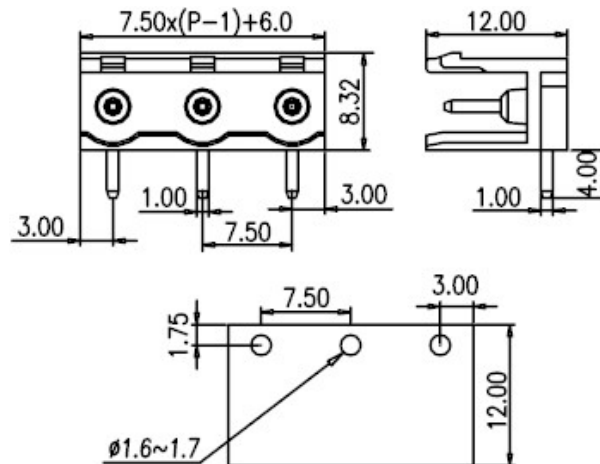

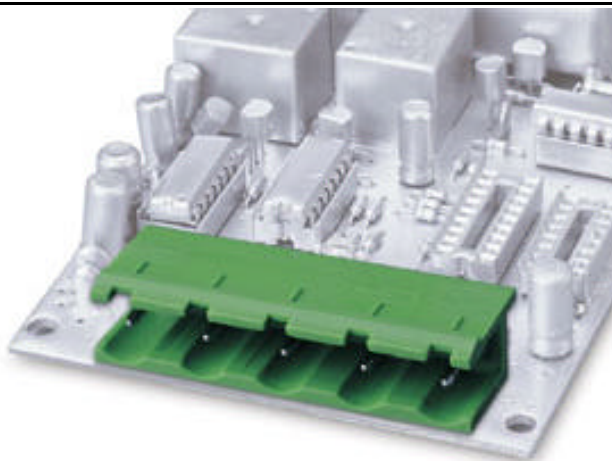

7EHDR



Pitch: 7.50mm

Approval	 	
Technical Data	UL	IEC
Rated voltage	300V	750V
Rated current	15A	17.5A
Wire range		
Solid wire (AWG)		
Stranded wire (AWG/mm ²)		
Rated surge voltage (UL/IEC/Max.)	1.6 / 3 / 4 KV	
Torque (Lb-in)		
Screw		
Wire strip length		
Pole	Cat. No.	
02	7EHDR-02P	
:	:	
:	:	
12	7EHDR-12P	