

Spring plugs for pluggable terminal blocks / 0134 series

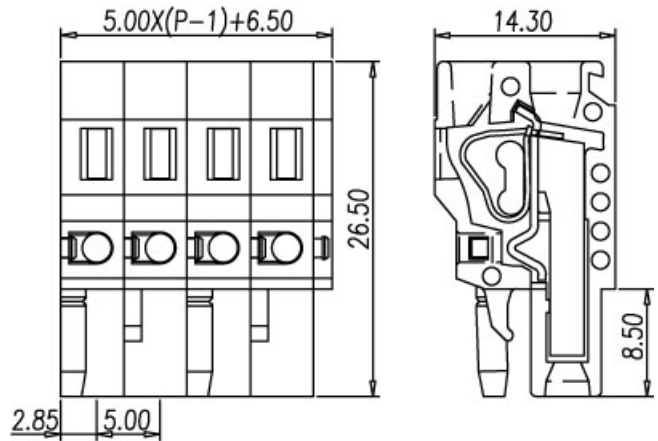

0134-11



Pitch: 5.00mm

Approval	UL	
Technical Data	UL	IEC
Rated voltage	300V	250V
Rated current	15A	12A
Wire range		1.5mm ²
Solid wire (AWG)	26~14	
Stranded wire (AWG/mm ²)		
Rated surge voltage (UL/IEC/Max.)	1.6 / 2 / KV	
Torque (Lb-in)		
Screw		
Wire strip length	10~11mm	
Pole	Cat. No.	
01	0134-1101	
02	0134-1102	
03	0134-1103	
:	:	

TEL: +886-2-2908-0614

FAX: +886-2-2908-8549

E-mail: infor@dinkle.com.tw